



NCF 2922 CV Single row full complement cylindrical roller bearing, NCF design

Single row full complement cylindrical roller bearing, NCF design

Single row full complement cylindrical roller bearings are designed to accommodate very high radial loads in combination with moderate speeds. The bearings incorporate a maximum number of rollers as they are not equipped with a cage. Having two integral flanges on the inner ring and one flange on the outer ring, NCF design bearings can accommodate axial displacement in one direction. A retaining ring on the outer ring holds the bearing together. The retaining ring should not be loaded axially during operation.

- Very high radial load carrying capacity
- High radial stiffness
- Long service life
- Locate the shaft axially in one direction

Overview

Dimensions

Bore diameter	110 mm
Outside diameter	150 mm
Width	24 mm

Performance

Basic dynamic load rating	134 kN
Basic static load rating	220 kN
Reference speed	1 900 r/min
Limiting speed	2 400 r/min

Properties

Bearing part	Complete bearing
Axial displacement capability	In one direction
Number of rows	1
Locating feature, bearing outer ring	None
Bore type	Cylindrical
Cage	Without
Design	Non-separable
Number of flanges, outer ring	1
Number of flanges, inner ring	2
Loose flange	None

Radial internal clearance	CN
Tolerance class	Normal
Coating	Without
Sealing	Without
Lubricant	None
Relubrication feature	Without

Technical Specification



Dimensions

d	110 mm	Bore diameter
D	150 mm	Outside diameter
B	24 mm	Width
d_1	≈ 124 mm	Shoulder diameter inner ring
D_1	≈ 136 mm	Shoulder diameter outer ring
E	141.1 mm	Raceway diameter outer ring
s	max. 1.3 mm	Permissible axial displacement from the normal position of one bearing ring relative to the other
$r_{1,2}$	min. 1.1 mm	Chamfer dimension
$r_{3,4}$	min. 1 mm	Chamfer dimension

Abutment dimensions

d_a	min. 116 mm	Abutment diameter shaft
d_{as}	122 mm	Abutment diameter shaft
D_a	max. 144 mm	Abutment diameter housing
D_b	max. 144 mm	Abutment diameter housing
r_a	max. 1 mm	Fillet radius
r_b	max. 1 mm	Fillet radius

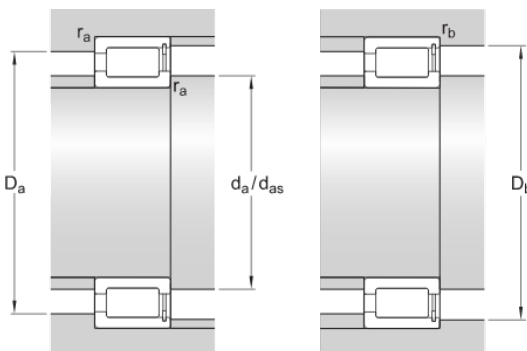

Calculation data

Basic dynamic load rating	C	134 kN
Basic static load rating	C ₀	220 kN
Fatigue load limit	P _u	26 kN
Reference speed		1 900 r/min
Limiting speed		2 400 r/min
Calculation factor	k _r	0.2
Limiting value	e	0.3
Calculation factor	Y	0.4

Mass

Mass bearing		1.17 kg
--------------	--	---------

Terms and conditions

By accessing and using this website / app owned and published by AB SKF (publ.) (556007-3495 · Gothenburg) ("SKF"), you agree to the following terms and conditions:

Warranty Disclaimer and Limitation of Liability

Although every care has been taken to assure the accuracy of the information on this website / app, SKF provides this information "AS IS" and DISCLAIMS ALL WARRANTIES, EXPRESS OR IMPLIED, INCLUDING, BUT NOT LIMITED TO, IMPLIED WARRANTIES OF MERCHANTABILITY AND FITNESS FOR A PARTICULAR PURPOSE. You acknowledge that your use of this website / app is at your sole risk, that you assume full responsibility for all costs associated with use of this website / app, and that SKF shall not be liable for any direct, incidental, consequential, or indirect damages of any kind arising out of your access to, or use of the information or software made available on this website / app. Any warranties and representations in this website / app for SKF products or services that you purchase or use will be subject to the agreed upon terms and conditions in the contract for such product or service. Further, for non-SKF websites / apps that are referenced in our website / app or where a hyperlink appears, SKF makes no warranties concerning the accuracy or reliability of the information in these websites / apps and assumes no responsibility for material created or published by third parties contained therein. In addition, SKF does not warrant that this website / app or these other linked websites / apps are free from viruses or other harmful elements.

Third Party Services

When viewing YouTube content via the SKF website(s) (i.e. using YouTube API Services), you agree to be bound by the YouTube Terms of Service.

Copyright

Copyright in this website / app copyright of the information and software made available on this website / app rest with SKF or its licensors. All rights are reserved. All licensed material will reference the licensor that has granted SKF the right to use the material. The information and software made available on this website / app may not be reproduced, duplicated, copied, transferred, distributed, stored, modified, downloaded or otherwise exploited for any commercial use without the prior written approval of SKF. However, it may be reproduced, stored and downloaded for use by individuals without prior written approval of SKF. Under no circumstances may this information or software be supplied to third parties.

This website /app includes certain images used under license from Shutterstock, Inc.

Trademarks and Patents

All trademarks, brand names, and corporate logos displayed on the website / app are the property of SKF or its licensors, and may not be used in any way without prior written approval by SKF. All licensed trademarks published on this website / app reference the licensor that has granted SKF the right to use the trademark. Access to this website / app does not grant to the user any license under any patents owned by or licensed to SKF.

Changes

SKF reserves the right to make changes or additions to this website / app at any time.